

Sales Code: BAZSE033

Description: 1700X750 Eternalite Bath Panel & Screen



Packaging Details

Barcode: 5056678407899

Sales Code: BMON014

Description: Round Se Bath & Leg Set 1700X750 EI

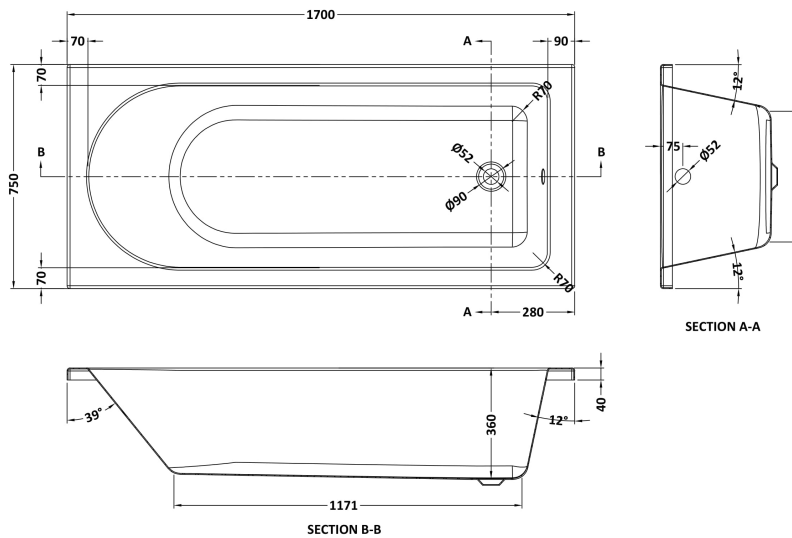

Product Dimensions

Length (mm):	1700
Width (mm):	750
Depth (mm):	400
Nett Weight (kg):	27

Packaging Dimensions

Length (mm):	1770
Width (mm):	760
Depth (mm):	400
Gross Weight (kg):	27

Packaging Data

Box Colour:	Brown Cardboard Sleeve
Box Qty:	1
Label Size:	100 x 50
Label Colour:	White Label
Label Qty:	2

Outer Box Dimensions (If Applicable)

Length (mm):	
Width (mm):	
Height (mm):	
Gross Weight (kg):	
Barcode:	5055369060948

Product Details

Country of Origin:	Egypt
Fitting Instruction:	No
Certification:	FSC: CE & UKCA:
Material Colour Reference:	European White
Product Material:	Acrylic With Eternalite
Material Thickness:	4mm
Volume (Ltr):	166L
Displaced Capacity:	96L
Leg Set Included:	Legset Included
Waste Included:	Waste Not Included
Drilled/Undrilled:	Undrilled For Taps
Includes Grips:	No Grips Supplied
Embossed:	No
No of Tapholes:	None
Anti-Slip:	No

Sales Code: PAN140

Description: Straight Bath Front Panel 1700X510x25mm



Product Dimensions

Length (mm):	1700
Width (mm):	525
Depth (mm):	20
Nett Weight (kg):	2.1

Packaging Dimensions

Length (mm):	1700
Width (mm):	525
Depth (mm):	35
Gross Weight (kg):	2.1

Packaging Data

Box Colour:	Polybagged With End Caps
Box Qty:	1
Label Size:	100 x 50
Label Colour:	White Label
Label Qty:	1

Outer Box Dimensions (If Applicable)

Length (mm):	
Width (mm):	
Height (mm):	
Gross Weight (kg):	
Barcode:	5055369060832

Product Details

Country of Origin:	United Kingdom
Fitting Instruction:	No
Certification:	FSC: N/A CE & UKCA: N/A
Material Colour Reference:	European White
Product Material:	Acrylic
Material Thickness:	2mm
Volume (Ltr):	N/A
Displaced Capacity:	N/A
Leg Set Included:	Not Applicable
Waste Included:	Not Applicable
Drilled/Undrilled:	Not Applicable
Includes Grips:	Not Applicable
Embossed:	No
No of Tapholes:	Not Applicable
Anti-Slip:	Not Applicable

Sales Code: NSSQ1

Description: Square Double Bath Screen (6)



Product Dimensions

Height (mm):	1433
Width (mm):	998
Depth (mm):	24
Nett Weight (kg):	24

Packaging Dimensions

Height (mm):	55
Width (mm):	1020
Length (mm):	1460
Gross Weight (kg):	24

Packaging Data

Box Colour:	Brown Cardboard Box - Printed
Box Qty:	1
Label Size:	100 x 50
Label Colour:	Not Applicable
Label Qty:	0

Outer Box Dimensions (If Applicable)

Height (mm):	
Width (mm):	
Depth (mm):	
Length (mm):	
Gross Weight (kg):	
Barcode:	5055369001361

Product Details

Country of Origin:	China
Fitting Instruction:	No
CE & UKCA:	Yes
Profile Material:	Aluminium
Profile Finish:	Chrome
Adjustments (mm):	770mm - 785mm
Entry Width (mm):	N/A
Swing In Dim (mm):	700mm
Swing Out Dim (mm):	700mm
Radius (mm):	Not Applicable
Glass Thickness (mm):	6
Easy Fit:	No
Easy Clean:	No
Handle Style:	Not Applicable
Handle Material:	Not Applicable
Enclosure Design:	Frameless
Wheel Type:	Not Applicable
Support Bar Included:	Support Bar Not Included
Extras:	None