

Sales Code: FLU393

Description: 600 W/H 2-Drawer Unit

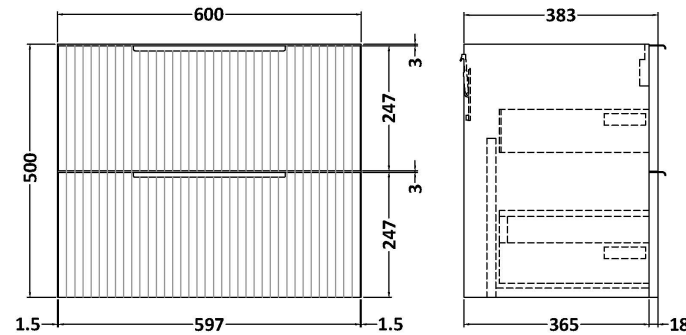
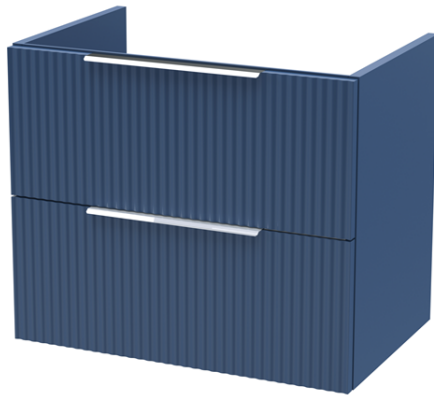

Product Dimensions

Height (mm):	500
Width (mm):	600
Depth (mm):	383
Nett Weight (kg):	22.5

Packaging Dimensions

Height (mm):	520
Width (mm):	620
Depth (mm):	405
Gross Weight (kg):	23

Packaging Data

Box Colour:	Brown Cardboard Box - Printed
Box Qty:	0
Label Size:	0 x 0
Label Colour:	Not Applicable
Label Qty:	0

Outer Box Dimensions (If Applicable)

Height (mm):	
Width (mm):	
Depth (mm):	
Gross Weight (kg):	
Barcode:	5056462654720

Product Details

Country of Origin:	China
Fitting Instruction:	No
CE & UKCA:	
FSC Certified Materials:	Yes
Colour:	Satin Blue
Construction Method:	Cam & Wood Dowel
Construction Type:	Rigid
Cabinet Finish:	MFC Painted Gloss
Fascia Finish:	Mdf Painted Gloss
Cabinet Thickness (mm):	16
Fascia Thickness (mm):	18
Drawer Included:	Yes
Drawer Type:	80mm High Metal Softclose
No of Shelves:	0
Hinge Type:	Not Applicable
Hinge Included:	No
Adjustable Legs:	No, Not Required
Fixings Included:	Yes
Handle Style:	Modern
Waste Shroud:	Yes
Handle Included:	Yes, Supplied
Handle Type:	Finger Pull