

Sales Code: HT301

Description: Countess Heated Towel Rail 966X676mm

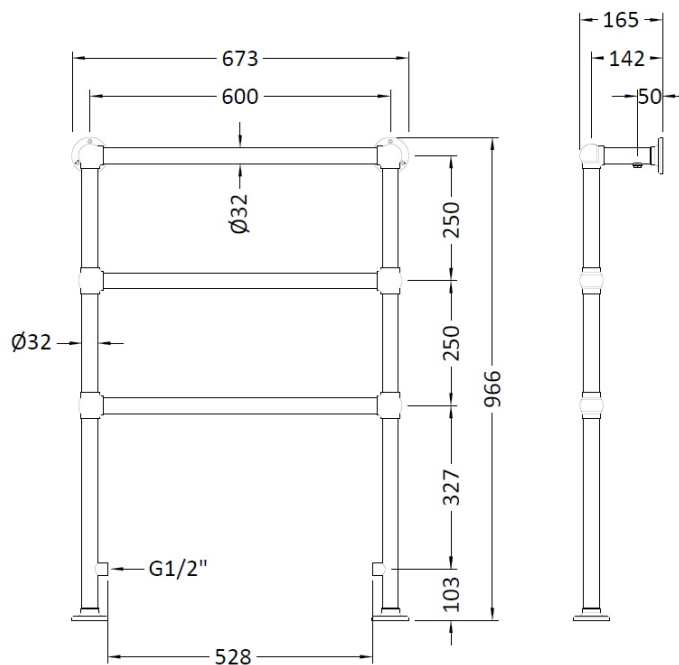

Product Dimensions

Height (mm):	966
Width (mm):	673
Depth (mm):	165
Length (mm):	
Nett Weight (kg):	6.35

Packaging Dimensions

Height (mm):	180
Width (mm):	695
Length (mm):	990
Gross Weight (kg):	7.7

Packaging Data

Box Colour:	White Cardboard Shrinkwrapped
Box Qty:	1
Label Size:	100 x 50
Label Colour:	White Label
Label Qty:	2

Outer Box Dimensions (If Applicable)

Height (mm):	
Width (mm):	
Length (mm):	
Gross Weight (kg):	
Barcode:	5055146123583

Product Details

Country of Origin:	China
Fitting Instruction:	No
Certification:	CE & UKCA: No RoHS: N/A WEEE: N/A
Colour/Finish:	Chrome
RAL No:	N/A
Product Material:	Steel
Heat Element Wattage:	Not Applicable
Heating Element Wattage Compatible:	N/A
BTU Outputs:	30°C / 287 50°C / 546 60°C / 691
Thermal Outputs: (Watts)	30°C / 84 50°C / 160 60°C / 200
Pipe Centres - If Vertical:	509mm
Pipe Centres - If Horizontal:	N/A
Max Projection:	160mm
Tube Diameter:	32mm
Packaging Volume (L):	124
Wall to Centre of Tappings:	100
Floor to Centre of Tappings:	145
Dual Fuel:	N/A
IP Rating:	