

Sales Code: LDR005

Description: Farrington Radiator

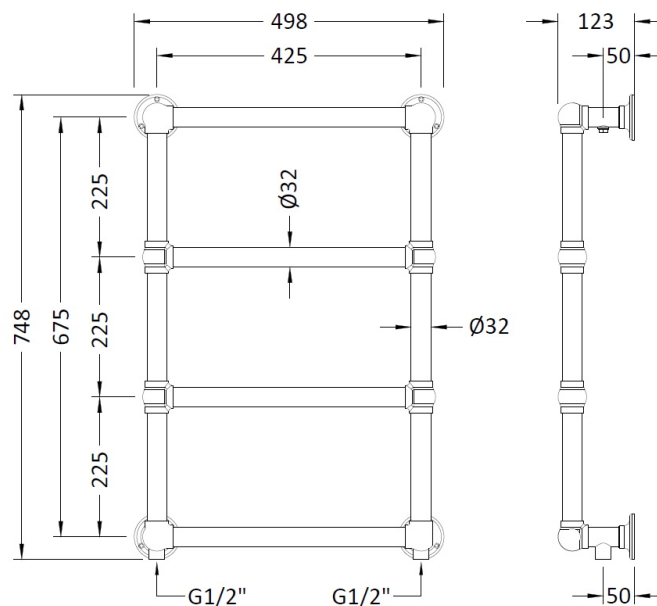

Product Dimensions

Height (mm):	748
Width (mm):	498
Depth (mm):	123
Length (mm):	
Nett Weight (kg):	5.8

Packaging Dimensions

Height (mm):	140
Width (mm):	520
Length (mm):	775
Gross Weight (kg):	6.8

Packaging Data

Box Colour:	White Cardboard Shrinkwrapped
Box Qty:	1
Label Size:	100 x 50
Label Colour:	White Label
Label Qty:	2

Outer Box Dimensions (If Applicable)

Height (mm):	
Width (mm):	
Length (mm):	
Gross Weight (kg):	
Barcode:	5055369036356

Product Details

Country of Origin:	China		
Fitting Instruction:	No		
Certification:	CE & UKCA: No	RoHS: N/A	WEEE: N/A
Colour/Finish:	Chrome		
RAL No:	N/A		
Product Material:	Steel		
Heat Element Wattage:	Not Applicable		
Heating Element Wattage Compatible:	N/A		
BTU Outputs:	30°C / 267	50°C / 502	60°C / 636
Thermal Outputs: (Watts)	30°C / 78	50°C / 147	60°C / 184
Pipe Centres - If Vertical:			
Pipe Centres - If Horizontal:			
Max Projection:	123mm		
Tube Diameter:	32mm		
Packaging Volume (L):			
Wall to Centre of Tappings:	N/A		
Floor to Centre of Tappings:	50		
Dual Fuel:	N/A		
IP Rating:			