

## 1. IN A TYPICAL INSTALLATION

ILLUSTRATED TO THE RIGHT ARE TYPICAL INSTALLATIONS WHERE AN EXTENSION KIT MAYBE NEEDED.

THIS EXTENSION KIT CAN BE USED ON ONE SIDE OR BOTH SIDES IF REQUIRED.

**IMPORTANT:**  
WHEN FITTING, ENSURE THAT THE SILICONE GROOVE (INDICATED BELOW) IS ON THE OUTSIDE OF THE ENCLOSURE.

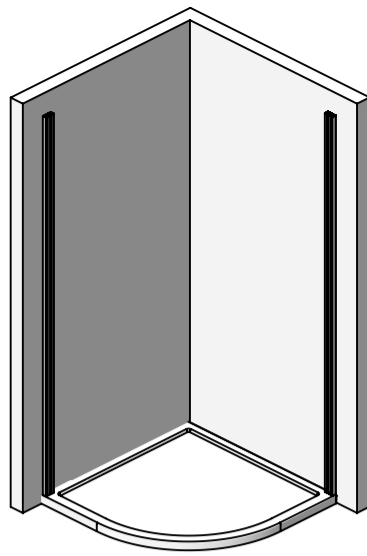
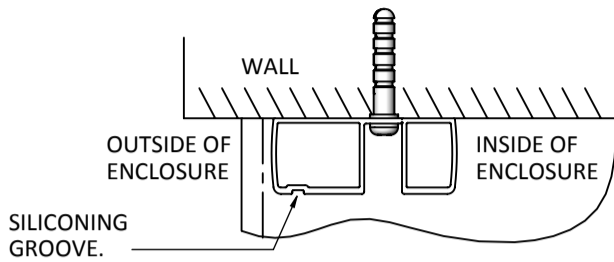

TYPICAL QUADRANT APPLICATION

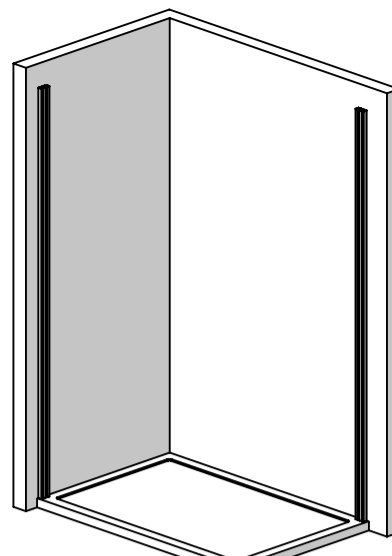

TYPICAL SIDE PANEL/CORNER ENTRY APPLICATION

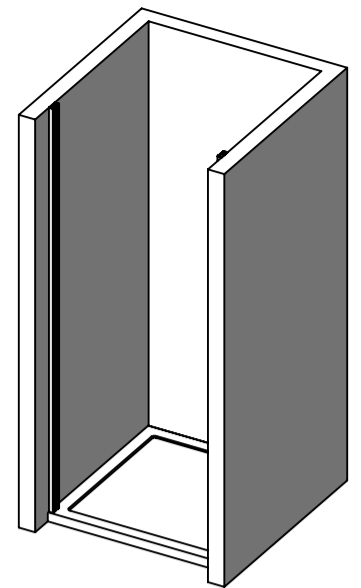

TYPICAL ALCOVE APPLICATION

## 2.

ONCE YOU HAVE DETERMINED WHICH SIDE REQUIRES THE EXTENSION PROFILES, FIT AS FOLLOWS.

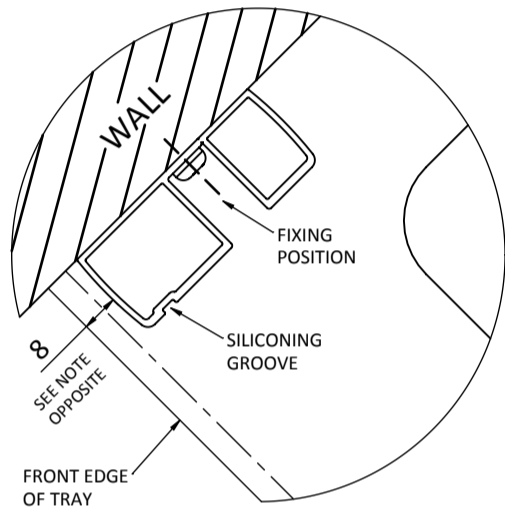

ENSURE THAT THE SILICONING GROOVE ON THE PROFILE IS TO THE OUTSIDE OF THE ENCLOSURE.

ALSO ENSURE THAT YOUR ENCLOSURE WILL STILL BE CONCENTRIC TO THE TRAY FRONT EDGE WHEN FIXED IN PLACE. YOU CAN ESTABLISH THIS BY DRY FITTING THE ENCLOSURE FRAME ON THE TRAY. USE 8mm AS AN INITIAL GUIDE FOR FITTING THE EXTENSION PROFILES.

NOW MARK THROUGH THE EXTENSION PROFILE FIXING HOLES WITH A PENCIL.

REMOVE PROFILE/S AND DRILL AND PLUG THE WALL USING 6mm MASONRY DRILL BIT.

FIX THE PROFILE/S TO THE WALL USING THE SCREWS & PLUGS PROVIDED WITHIN THE SHOWER ENCLOSURE BOX.

## 3.

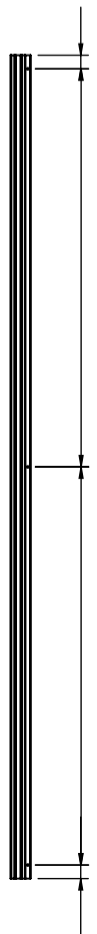
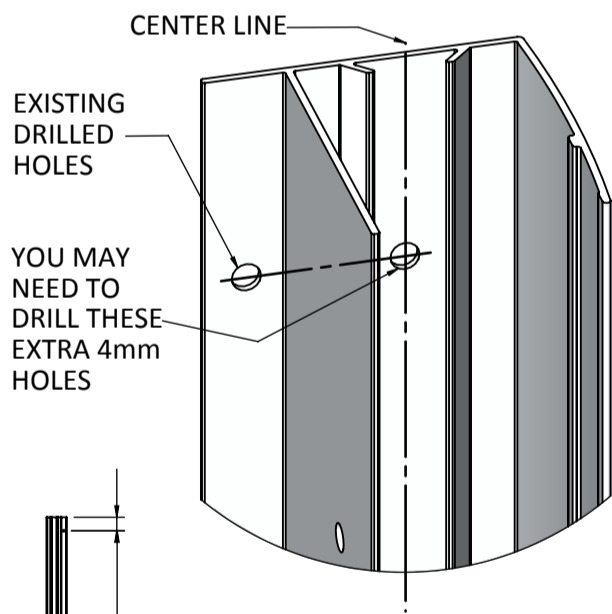

SOME WALL PROFILES WILL NEED EXTRA HOLES DRILLING FOR FITTING TO THE EXTENSION PROFILES.

IF YOU NEED TO DRILL EXTRA HOLES USE A 4.00mm DRILL BIT TO DRILL THREE HOLES IN LINE WITH THE EXISTING HOLES, BUT AS ILLUSTRATED ABOVE CENTRAL TO THE 'U' SHAPE PROFILE CHANNEL.

## 4.

ONCE THE EXTENSION PROFILE/S HAVE BEEN FIXED TO THE WALL AND THE ENCLOSURE WALL PROFILE/S HAVE BEEN DRILLED (IF NECESSARY), OFFER THE ENCLOSURE FRAME UP TO THE EXTENSION PROFILE/S AND POSITION THE FRAME AS PER THE DIAGRAMS BELOW.

### PACIFIC/APEX ENCLOSURES

OUTSIDE OF ENCLOSURE

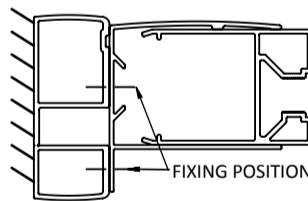

### ELLA ENCLOSURES (EXCLUDING QUADRANT)

OUTSIDE OF ENCLOSURE

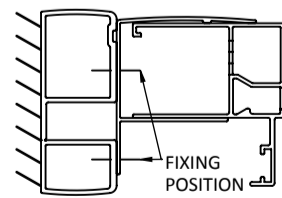

WHEN CORRECTLY ALIGNED, MARK THROUGH THE FIXING HOLES SHOWN ABOVE ON TO THE EXTENSION PROFILE.

REMOVE THE ENCLOSURE FRAME AND DRILL WHERE MARKED USING A 3.00mm DRILL BIT.

## 5.

BEFORE FIXING THE FRAME WITH THE SCREWS YOU WILL NEED TO RUN A BEAD OF SILICONE DOWN THE ENTIRE LENGTH OF THE SILICONING GROOVE ON THE EXTENSION PROFILE, STOPPING A FEW CENTIMETERS SHORT FROM THE TOP.

OFFER THE ENCLOSURE FRAME BACK UP TO THE EXTENSION PROFILE/S AND REALIGN.

WHEN FIXING THE ENCLOSURE WITH THE SCREWS, IF YOU HAVE THE SCREW COVER CAPS & CUPS FROM THE ENCLOSURE, BE SURE TO USE THEM WHEN FIXING EXPOSED SCREWS. SEE DIAGRAM BELOW.

### PACIFIC/ELLA ENCLOSURES

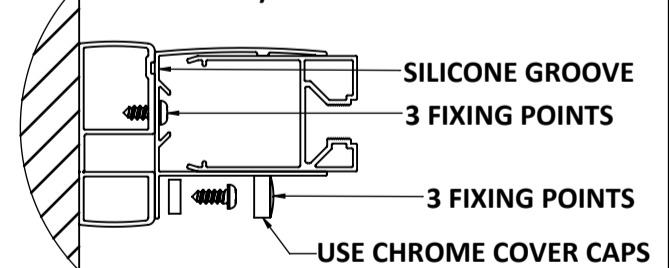

### APEX ENCLOSURE

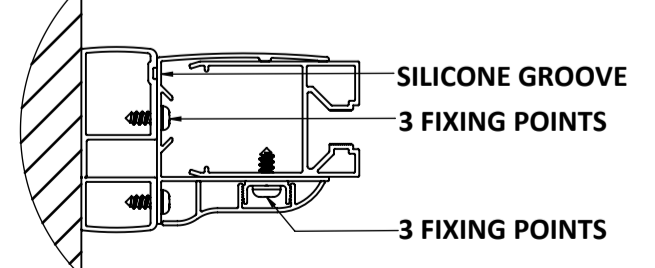

ONCE YOU HAVE FIXED THE ENCLOSURE FRAME TO THE EXTENSION PROFILES CONTINUE WITH THE REST OF THE ENCLOSURE ASSEMBLY.

PLACE THE EXTENSION PROFILE CAPS WHEN TOLD TO PLACE THE ENCLOSURE CAPS IN THE ENCLOSURE INSTRUCTION.

THIS SILICONING SHOULD BE DONE ONCE YOU HAVE FINISHED BUILDING UP THE ENTIRE ENCLOSURE.

EXTERNALLY SILICONE SEAL THE EXTENSION PROFILE/S WHERE THEY MEET THE WALL, ALL IN A CONTINUOUS BEAD.

ALSO SILICONE THE ENTIRE LENGTH OF THE EXTENSION PROFILE WHERE IT MEETS THE ENCLOSURE PROFILE, CLEANING ANY EXCESS SILICONE.

TO COMPLETE THE SILICONING REFER TO YOUR ENCLOSURE INSTRUCTION.

DO NOT SILICONE INSIDE THE ENCLOSURE.

ALLOW THE SILICONE AT LEAST 24 HOURS TO FULLY CURE.

**AFTERCARE:** ENSURE YOU CLEAN YOUR PRODUCT USING A MILD DETERGENT DILUTED IN WATER, REMOVING ANY RESIDUE WITH A SOFT DAMP CLOTH.

**MAINTENANCE:** ENSURE MOVING PARTS ARE FREE FROM ANY DEBRIS OR SOAP BUILD UP.

**ENCLOSURE WITH WHEELS:** THE WHEELS MUST ROTATE FREELY AND THE SPRING LOADED MECHANISM IN THE BOTTOM WHEELS MUST OPERATE WITHOUT INTERFERENCE.

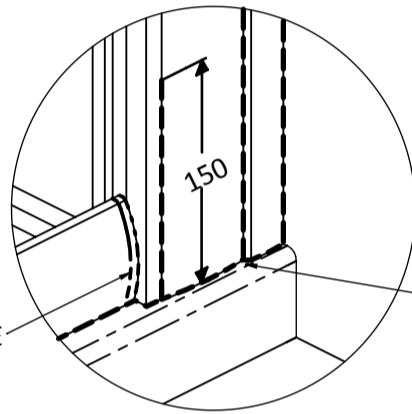
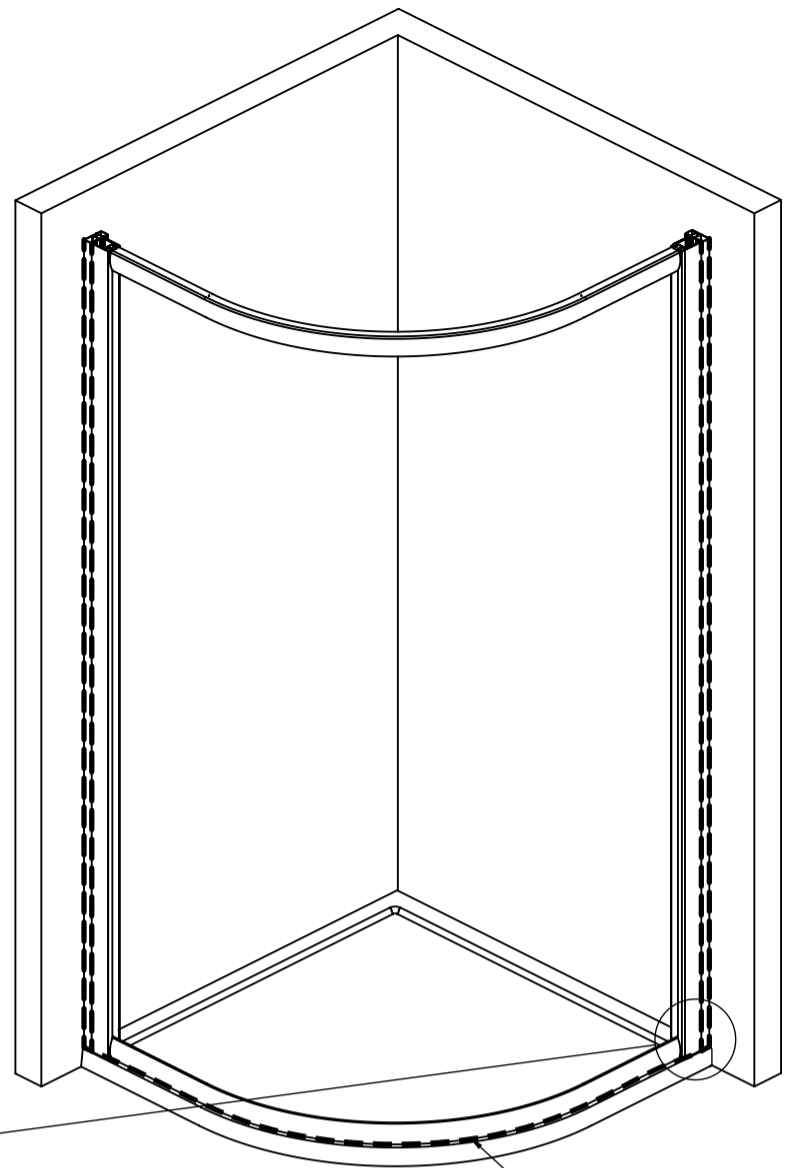

WITH AS SMALL A BEAD AS POSSIBLE

EXTENSION PROFILE MEETS ENCLOSURE PROFILE.

ALL IN A CONTINUOUS BEAD.

**EXTENSION PROFILE INSTALLATION - USE FOR ALL ENCLOSURES EXCEPT ELLA QUAD**

**INSTRUCTION NOT FOR USE ON AN ELLA QUAD**

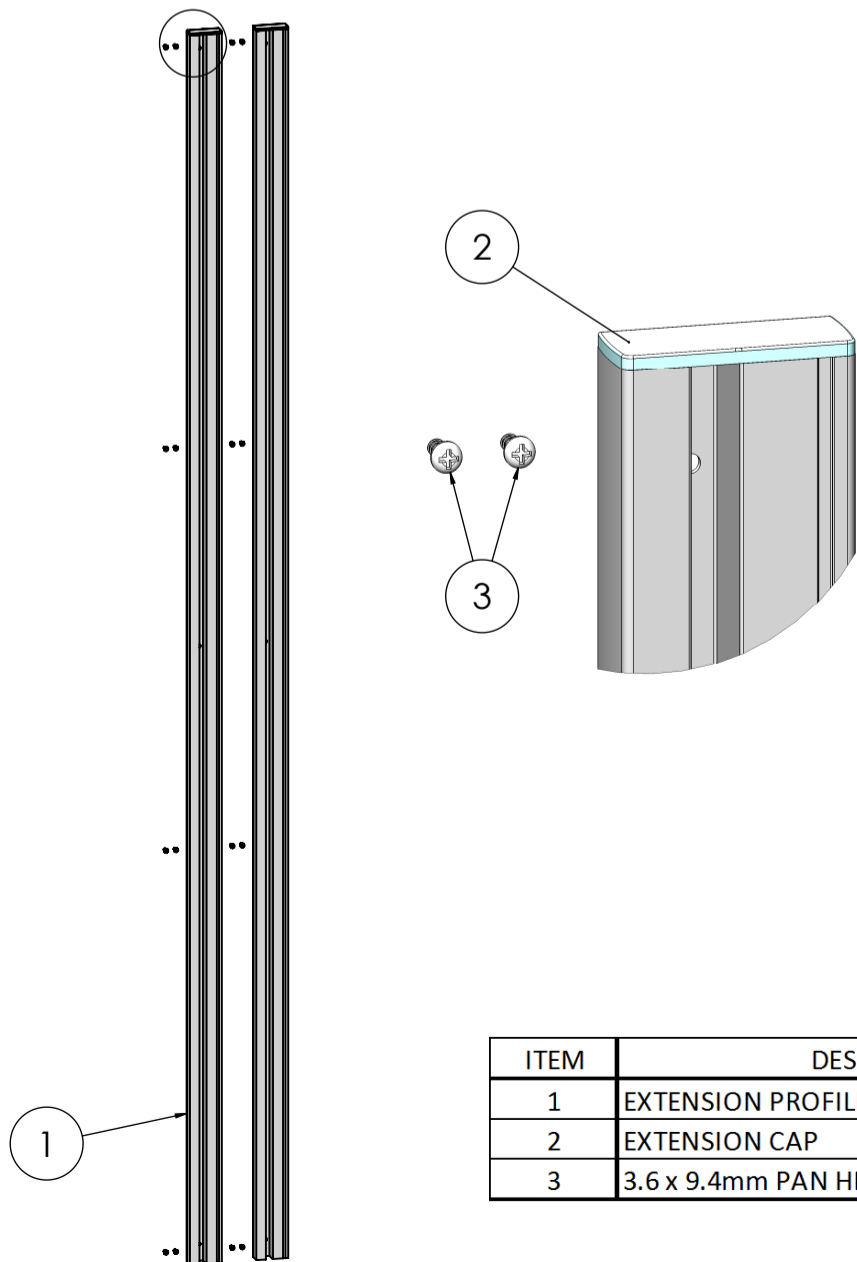

THIS KIT IS TO BE USED IN CONJUNCTION WITH THE ENCLOSURE FITTING INSTRUCTION.

UNPACK THE BOX AND ENSURE ALL COMPONENTS ARE PRESENT.

NO REFUNDS OR REFITTING COST WILL BE GIVEN IF INCOMPLETE OR DAMAGED GOODS ARE FITTED.

ENSURE THE SHOWER TRAY IS FITTED AS PER THE MANUFACTURERS INSTRUCTION.

NOTE: IF THE TRAY ISN'T TRUE AND LEVEL, IT MUST BE RECTIFIED BEFORE ANY PARTS ARE FITTED TO THE WALLS.

**TOOLS REQUIRED**

POWER DRILL - 6mm MASONARY DRILL BIT - 3mm & 4mm DRILL BITS - CROSS HEAD SCREW DRIVER - TAPE MEASURE - PENCIL - SILICONE GUN WITH SANITARY GRADE SEALANT - SPIRIT LEVEL.

ITEM	DESCRIPTION	Note	QTY
1	EXTENSION PROFILE		2
2	EXTENSION CAP		2
3	3.6 x 9.4mm PAN HD SELF TAPPER SCREW		16